

PROLED LED PANEEL RGBW L800x000

Eigenschaften:

- SMD CHIP RGBW
- Spannungsversorgung 24 VDC, 73 Watt
- Metallrahmen quadratisch weiß
- Panel PMMA weiß Opal
- Abstrahlwinkel 120°
- Ansteuerbar über einen Dimmer
- Umgebungstemperatur -10° C bis +45° C
- CE-konform mit den zutreffenden europäischen Richtlinien
- Dieses Produkt enthält eine Lichtquelle der Energieeffizienzklasse G

Warnhinweise:

1. Nur für Innenbereich vorgesehen
2. Stellen Sie sicher, dass die Verpackung umweltgerecht entsorgt wird
3. Falls ein Kabel beschädigt ist, benutzen Sie nicht die Leuchte
4. Wir empfehlen den Einbau durch einen Fachbetrieb, der mit diesen Leuchten vertraut ist
5. Nicht direkt in das Leuchtmittel schauen

Sicherheit:

Beauftragen Sie mit der Installation eine Elektro-Fachkraft. Für Leuchten, die nicht gemäß den europäischen Sicherheitsrichtlinien installiert wurden, entfällt jeder Haftungsanspruch. Der Hersteller übernimmt keine Haftung für Schäden, die durch unsachgemäßen Einsatz oder Montage entstehen. Werden nachträglich Änderungen an der Leuchte vorgenommen, so gilt derjenige als Hersteller, der diese Änderungen vornimmt. Leuchte nicht mit wärmedämmenden Stoffen abdecken. Nur für den Innenbereich geeignet. Schutzart IP40.

Montage:

Beachten Sie vor Inbetriebnahme unbedingt die Reihenfolge der einzelnen Installationsschritte, da es ansonsten zu einer Beschädigung der LED kommen kann.

1. Schalten Sie vor Beginn der Arbeiten an der Leuchte die Stromzufuhr ab. Falls ein Sicherungskasten vorhanden ist, entfernen Sie die dazugehörige Sicherung und sichern diese gegen unbeabsichtigtes Einschalten.
2. Schließen Sie die Leuchte an den Dimmer an.
3. Verbinden Sie den Dimmer mit einem entsprechenden 24 VDC Netzteil.
4. Stellen Sie sicher, dass keine Leitung oder Litzen lose sind
5. Stellen Sie sicher, dass durch den Leuchten Einbau keine Feuerschutzbestimmungen verletzt werden
6. Falls Sie diese Anleitung nicht verstehen, kontaktieren Sie bitte einen Fachmann



Reihenfolge beachten, ansonsten Beschädigung der LED möglich:

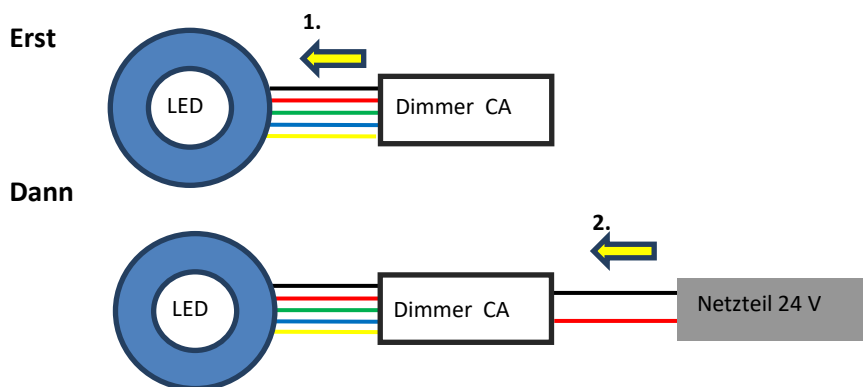

Die Montage und Inbetriebnahme darf nur vom qualifiziertem Personal durchgeführt werden. Nationale Vorgaben müssen eingehalten werden. Vor jeder Arbeit ist die Leuchte vom Netz zu trennen.

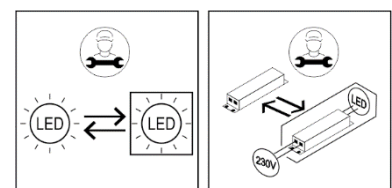

Montagearten:

1. Eingelegt in abgehängte Decke

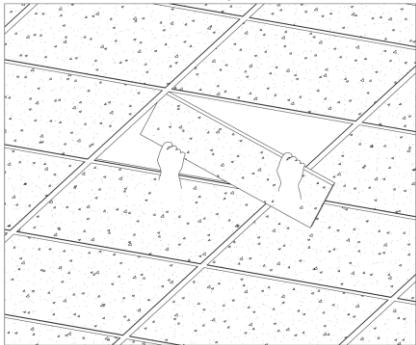
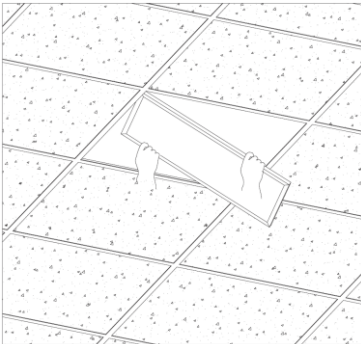
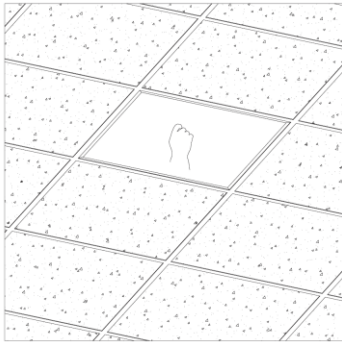
<p>Prüfen Sie zuerst die ausreichende Auflagefläche:</p> <table border="0"> <tr> <td>Panelgröße</td> <td>Notwendige Auflagefl.</td> <td>Gewicht</td> </tr> <tr> <td>595 x 595 mm</td> <td>580 x 580 mm ±1 mm</td> <td>ca. 4 kg</td> </tr> <tr> <td>622 x 622 mm</td> <td>605 x 605 mm ± 1 mm</td> <td>ca. 4,2 kg</td> </tr> </table>	Panelgröße	Notwendige Auflagefl.	Gewicht	595 x 595 mm	580 x 580 mm ±1 mm	ca. 4 kg	622 x 622 mm	605 x 605 mm ± 1 mm	ca. 4,2 kg	<p>Entnehmen Sie ein Deckenpaneel</p> 
Panelgröße	Notwendige Auflagefl.	Gewicht								
595 x 595 mm	580 x 580 mm ±1 mm	ca. 4 kg								
622 x 622 mm	605 x 605 mm ± 1 mm	ca. 4,2 kg								
<p>Setzen Sie das Paneel schräg mit ca. 30-45° ein</p> 	<p>Prüfen Sie, ob das Paneel überall vollflächig aufliegt. Seitliches Spiel darf nicht mehr als 3mm betragen, da sonst die Leuchte herunterfallen könnte.</p> 									

2. Befestigung mit Haltefedern

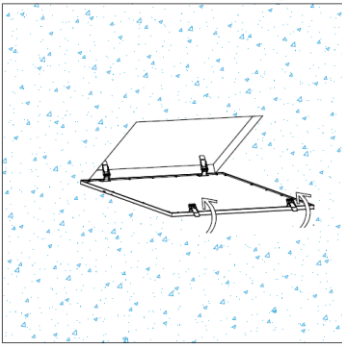
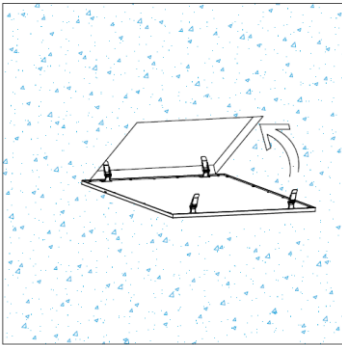
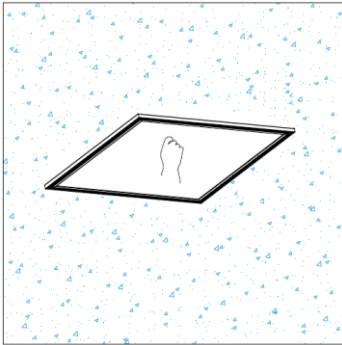
<p>Erstellen Sie einen Deckenausschnitt gemäß nachfolgenden Angaben:</p> <table border="0"> <tr> <td>Panelgröße</td> <td>Notwendiger Ausschn.</td> <td>Gewicht</td> </tr> <tr> <td>595 x 595 mm</td> <td>575 x 575 mm ±3 mm</td> <td>ca. 4 kg</td> </tr> <tr> <td>622 x 622 mm</td> <td>600 x 600 mm ±3 mm</td> <td>ca. 4,2 kg</td> </tr> </table> <p>Die Decke muss min. 1-2 cm Dicke haben, sonst kann die Leuchte herunterfallen.</p>	Panelgröße	Notwendiger Ausschn.	Gewicht	595 x 595 mm	575 x 575 mm ±3 mm	ca. 4 kg	622 x 622 mm	600 x 600 mm ±3 mm	ca. 4,2 kg	<p>Setzen Sie die Haltefedern einseitig ein</p> 
Panelgröße	Notwendiger Ausschn.	Gewicht								
595 x 595 mm	575 x 575 mm ±3 mm	ca. 4 kg								
622 x 622 mm	600 x 600 mm ±3 mm	ca. 4,2 kg								
<p>Heben Sie die gegenüber liegenden Haltefedern an und setzen Sie die Leuchte ein.</p>  <p>ACHTUNG: Treiber darf nicht auf der Leuchte liegen</p>	<p>Richten Sie die Leuchte so aus, dass sie den Deckenausschnitt abdeckt.</p> 									

3. Abgehängt an Seilen

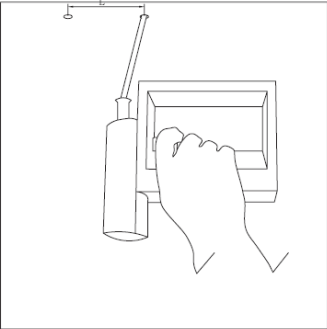
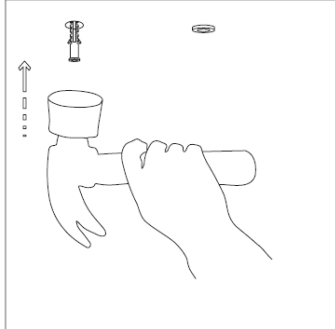
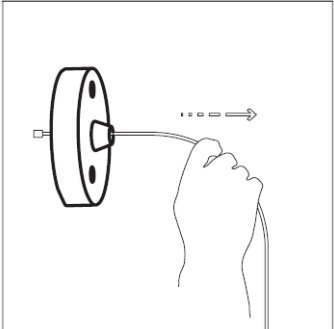
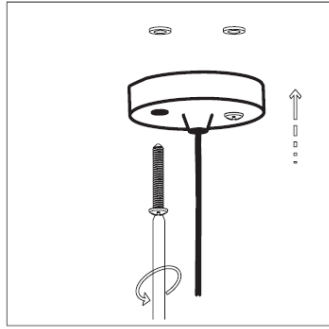
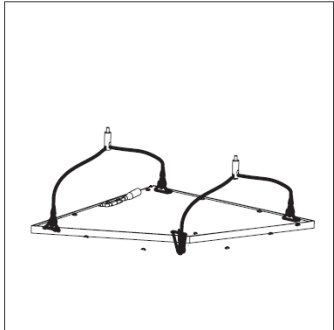
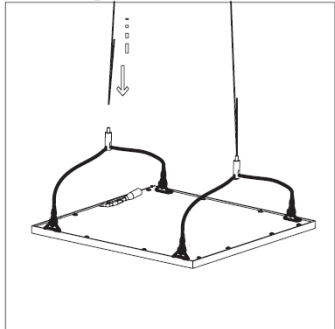
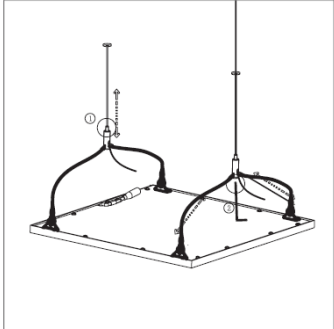
<p>Bohren Sie Löcher Ø6mm, 35mm tief. Abstand gemäß Aufhängung</p>  <p>Deckenstärke muss min. 50 mm sein, sonst kann die Leuchte herunterfallen</p>	<p>Setzen Sie den Dübel ein und stellen sicher, dass dieser bündig eingesetzt ist.</p> 						
<p>Setzen Sie das Seilende in den Flansch und stellen Sie sicher, dass die Seilendsicherung vorhanden ist.</p> 	<p>Befestigen Sie den Flansch an der Decke</p> 						
<p>Befestigen Sie die Aufhängungen an der Leuchte. Der Sicherungsverschluss muß geschlossen sein, sonst kann die Leuchte ggf. herunterfallen.</p> 	<p>Führen Sie die Abhängeseile in die Halterungen ein.</p> 						
<p>Richten Sie die Leuchte in der gewünschten Höhe und waagrecht aus.</p> 	<p>Abstand zwischen den Seilaufhängungen</p> <table border="1"> <thead> <tr> <th>Panelgröße</th> <th>Seilabstand</th> </tr> </thead> <tbody> <tr> <td>595 x 595</td> <td>535 mm</td> </tr> <tr> <td>622 x 622</td> <td>550 mm</td> </tr> </tbody> </table>	Panelgröße	Seilabstand	595 x 595	535 mm	622 x 622	550 mm
Panelgröße	Seilabstand						
595 x 595	535 mm						
622 x 622	550 mm						

4. Im Aufputz-Montagerahmen

<p>Bauen Sie den Rahmen gemäß rechter Darstellung zusammen, so dass ein dreiseitiger Rahmen entsteht.</p>	<p>Parts list: 4x screws, 4x nuts, 4x brackets, 16x washers, 4x panels.</p> <p>Step 1: Attach the first panel to the side rail.</p> <p>Step 2: Attach the second panel to the side rail.</p> <p>Step 3: Attach the third panel to the side rail.</p>
<p>Zeichnen Sie an der Decke die Befestigungslöcher gemäß den Löchern im Rahmen.</p>	<p>Diagram showing the three-sided frame being positioned against the ceiling. Arrows indicate the locations for marking the mounting holes.</p>
<p>Befestigen Sie den dreiseitigen Rahmen an der Decke mit Dübel und Schrauben.</p> <p>Schliessen Sie den Treiber an und schieben Sie das Paneel mit dem Treiber in den Rahmen hinein.</p>	<p>Diagram showing the three-sided frame being secured to the ceiling with a bracket and screw. A callout shows a hole diameter of 06. The next diagram shows the panel being inserted into the frame using a driver.</p>
<p>Befestigen sie die 4. Seite der Rahmens mit den Winkeln und restlichen Schrauben.</p>	<p>Diagram showing the fourth side of the frame being secured with brackets and screws. Callouts 7a, 7b, and 7c show the assembly details for the corner joints.</p>
<p>Die Leuchte kann nun verwendet werden.</p>	<p>Final diagram showing the completed rectangular light fixture installed in the ceiling.</p>

10.21 Technische Änderungen vorbehalten

PROLED LED PANEL RGBW L800x000

Characteristics:

- SMD CHIP RGBW
- Power consumption 24 VDC, 73 W
- Metall housing square white
- Panel PMMA white Opal
- Beam angle 120°
- Controllable with a Dimmer CA
- Operating temperature range -10° C till +45° C
- CE compliant with applicable European directives
- This product contains a light source of energy efficiency class G

Warning:

1. For indoor use only
2. Please ensure that the packaging is disposed of in a safe environment
3. If cable is defected, do not use the luminaire
4. We do recommend that a qualified electrician should be used to install the products
5. Do not look at the lighted lamp directly

Safety indices:

Be sure to have a qualified electrician complete installation. The customer is not entitled to claim for any lights installed without observing European safety directives. The manufacturer is then discharged from liability when damage is caused by improper use or installation. If any luminaire is subsequently modified, the person responsible for the modification shall be considered as manufacturer. Do not cover lamp with heat-insulating materials. For indoor use only. Protection class IP40.

Installation:

Please follow the sequence of installation step by step. Non-observance can lead to damage of LED.

1. Switch off the electricity at the mains before commencing installation or lamp change and (if a fuse box is installed) remove the appropriate circuit fuse to avoid accidental switching on of the mains supply.
2. Connect the luminaire to a dimmer
3. Connect the dimmer to a corresponding 24 VDC power supply
4. Make sure all connections are tight with no loose strands
5. Ensure fire regulations are not breached when fitting your lights
6. If you are in any doubt regarding these instructions, consult a qualified electrician



Please follow the sequence, if not destroying of LED:

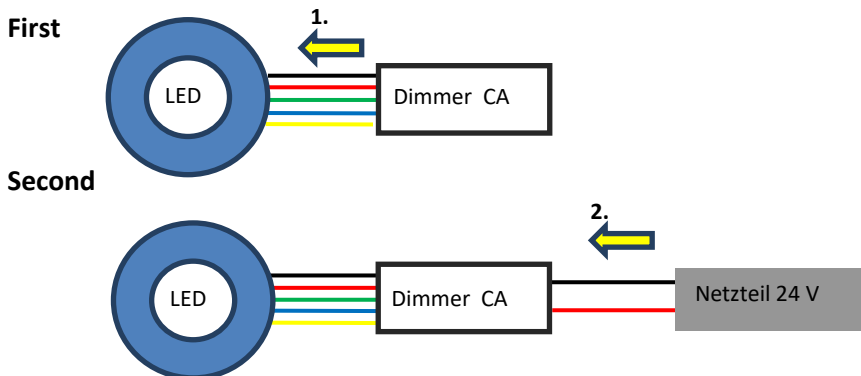

Installation and commissioning may only be performed by qualified persons. National installation regulations must be observed. Luminaires must be disconnected from mains before any work.

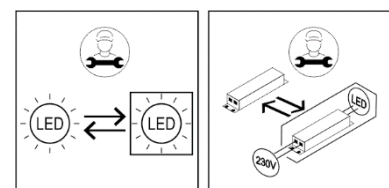

Mounting possibilities:

1. Recessed mounting

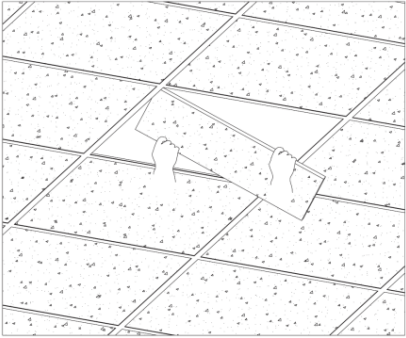
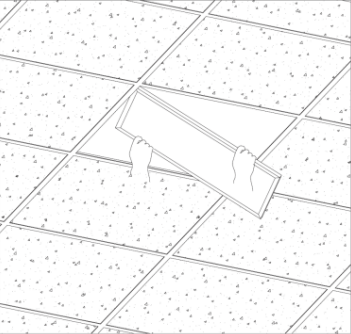
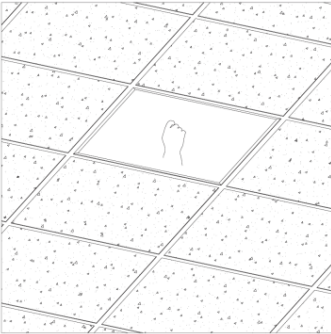
<p>First check if the recessed ceiling meets the requirements:</p> <table border="0"> <tr> <td>Panel size</td> <td>Channel dimension</td> <td>Weight</td> </tr> <tr> <td>595 x 595 mm</td> <td>580 x 580 mm ±1 mm</td> <td>ca. 4 kg</td> </tr> <tr> <td>622 x 622 mm</td> <td>605 x 605 mm ±1 mm</td> <td>ca. 4,2 kg</td> </tr> </table>	Panel size	Channel dimension	Weight	595 x 595 mm	580 x 580 mm ±1 mm	ca. 4 kg	622 x 622 mm	605 x 605 mm ±1 mm	ca. 4,2 kg	<p>Take out a ceiling panel</p> 
Panel size	Channel dimension	Weight								
595 x 595 mm	580 x 580 mm ±1 mm	ca. 4 kg								
622 x 622 mm	605 x 605 mm ±1 mm	ca. 4,2 kg								
<p>Insert the panel under a tilt of around 30-45°</p> 	<p>Check that panel rests everywhere with entire surface. Side distance can't be more than 3mm, otherwise the luminaire may fall down.</p> 									

2. Fixing with spring mounting clips

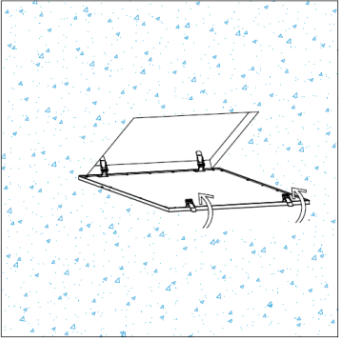
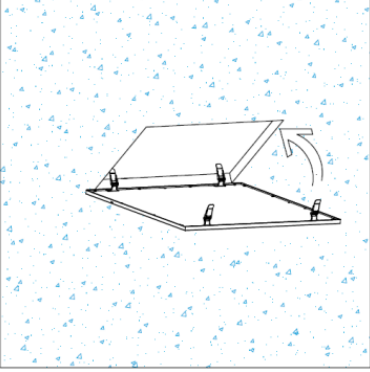
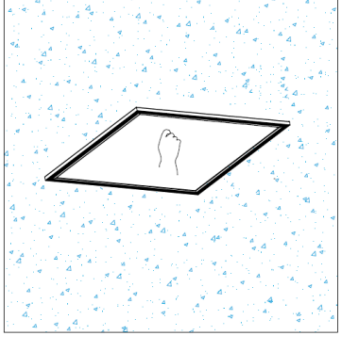
<p>Make a cutout in the suspended ceiling according to below dimensions:</p> <table border="0"> <tr> <td>Panel size</td> <td>Needed cutout</td> <td>Weight</td> </tr> <tr> <td>595 x 595 mm</td> <td>575 x 575 mm ±3 mm</td> <td>ca. 4 kg</td> </tr> <tr> <td>622 x 622 mm</td> <td>600 x 600 mm ±3 mm</td> <td>ca. 4,2 kg</td> </tr> </table> <p>The ceiling must have a thickness of min. 1-2 cm, else the luminaire may fall down.</p>	Panel size	Needed cutout	Weight	595 x 595 mm	575 x 575 mm ±3 mm	ca. 4 kg	622 x 622 mm	600 x 600 mm ±3 mm	ca. 4,2 kg	<p>Insert one side with spring mounting clip into ceiling</p> 
Panel size	Needed cutout	Weight								
595 x 595 mm	575 x 575 mm ±3 mm	ca. 4 kg								
622 x 622 mm	600 x 600 mm ±3 mm	ca. 4,2 kg								
<p>Lift up the opposite spring mounting clips and insert the luminaire.</p>  <p>ATTENTION: Driver can't lay on the luminaire</p>	<p>Adjust the lamp so that it covers the ceiling cut.</p> 									

3. Rope suspension

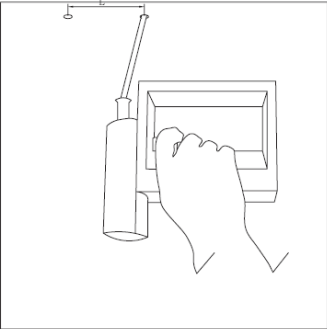
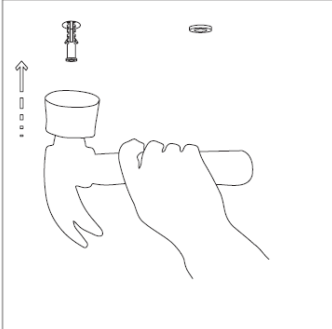
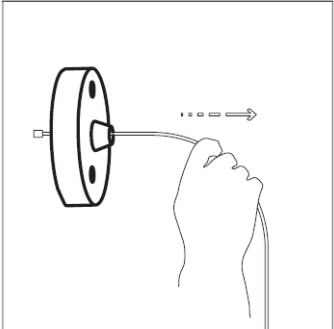
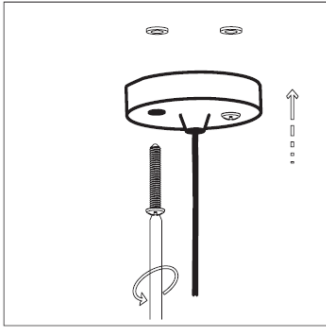
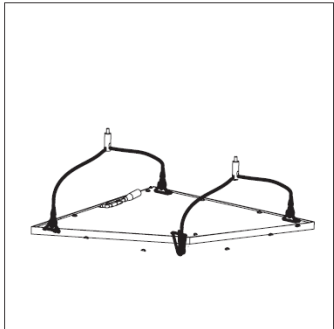
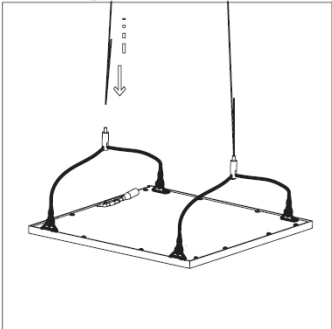
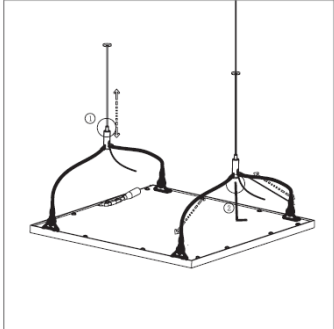
<p>Drill holes $\varnothing 6\text{mm}$, 35mm deep. Distance according to slots</p>  <p>Ceiling thickness must be min. 50 mm, else the luminaire might fall down</p>	<p>Insert the dowel and make sure it is installed flush</p> 						
<p>Put the rope end into flange and make sure, that a rope end secure exists.</p> 	<p>Fix the flange at the ceiling</p> 						
<p>Attach the hangers to the luminaire. The safety lock must be closed, otherwise the luminaire might fall down.</p> 	<p>Insert the ropes into the fixings.</p> 						
<p>Align the luminaire in the desired height and horizontally.</p> 	<p>Distance between rope fixings</p> <table data-bbox="798 1608 1145 1702"> <thead> <tr> <th>Panel size</th> <th>Rope distance</th> </tr> </thead> <tbody> <tr> <td>595 x 595</td> <td>535 mm</td> </tr> <tr> <td>622 x 622</td> <td>550 mm</td> </tr> </tbody> </table>	Panel size	Rope distance	595 x 595	535 mm	622 x 622	550 mm
Panel size	Rope distance						
595 x 595	535 mm						
622 x 622	550 mm						

4. Frame mounted on ceiling

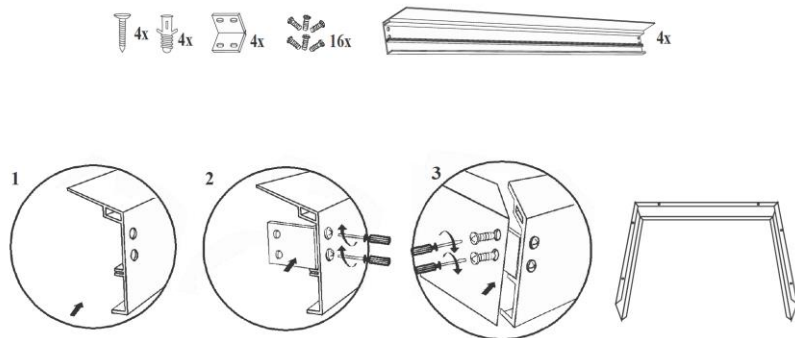
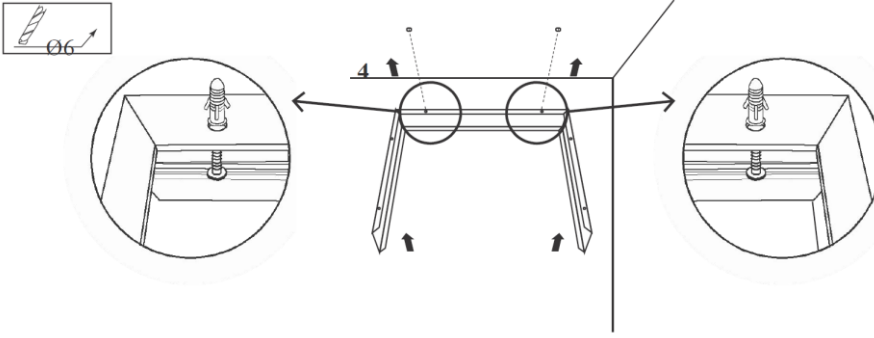
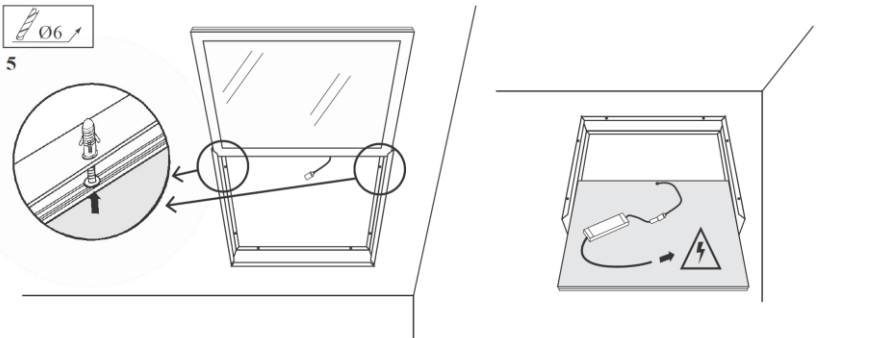
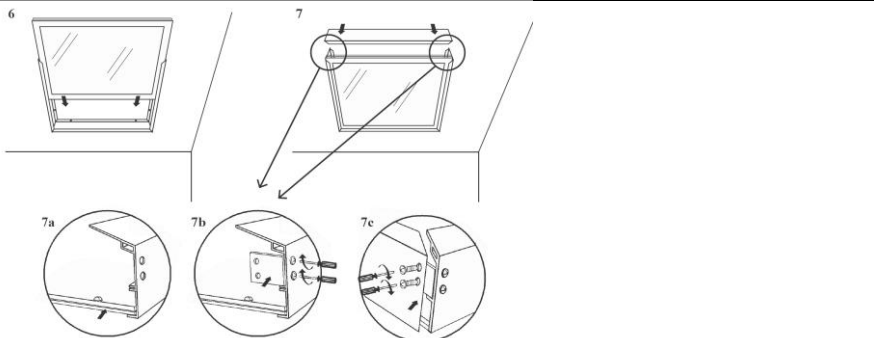
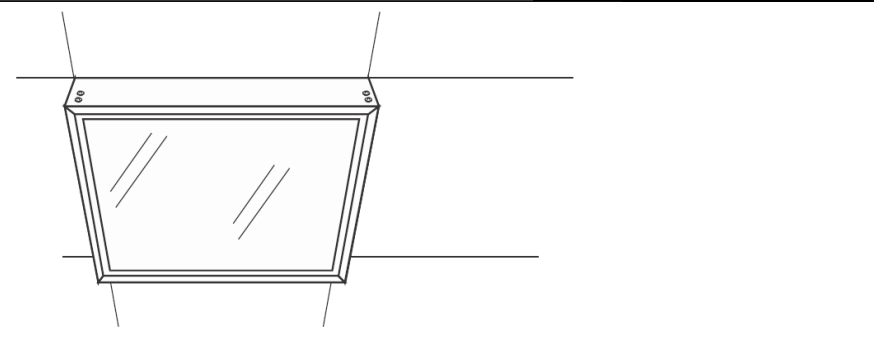
<p>Build the frame according to the right presentation, so that a three-sided frame is created.</p>	 <p>Parts list: 4x screws, 4x dowels, 4x angles, 16x screws, 4x frame sections.</p> <p>Step 1: Attach the first frame section to the ceiling.</p> <p>Step 2: Attach the second frame section to the first.</p> <p>Step 3: Attach the third frame section to the second.</p>
<p>Mark mounting holes on the ceiling, according to the holes in the frame.</p>	 <p>Diagram showing a pencil marking holes on the ceiling corresponding to the frame's mounting points.</p>
<p>Attach the three-sided frame to the ceiling with dowel and screws.</p> <p>Connect the driver panel and slide the panel with the driver into the frame.</p>	 <p>Diagram 5: Shows the three-sided frame being secured to the ceiling with dowels and screws. A driver panel is shown being inserted into the frame.</p>
<p>Attach the 4th side of the frame with angles and rest of the screws.</p>	 <p>Diagram 6: Shows the fourth side of the frame being attached to the ceiling.</p> <p>Diagram 7: Shows the final assembly steps for the fourth side, including sub-steps 7a, 7b, and 7c.</p>
<p>The luminaire can be used now.</p>	 <p>Diagram showing the completed luminaire installation, ready for use.</p>